



LARGE FORMATS

50x100 • 24,8x100 • 16,5x100



Create a modern style with **large format tiles**. From a traditional stone-look to a natural wood design, the best looks are expanding to stunning proportions. When each tile covers more square feet, fewer grout lines are required during installation, resulting in a more seamless look that is easier to clean. Large tiles concept is an easy way to modernize the look of your interior or exterior. It comes in a variety of designs and styles to complement any taste. Large format tile withstands foot traffic, they are water and stain-resistant, easy to clean.

ASPEN



(brown) (beige) (grey)

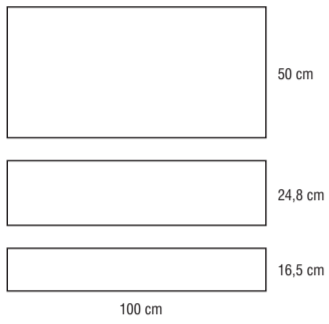

Rectified tiles are practically identical in terms of length and width - the machines used to cut them work to very fine tolerances. Rectified tiles are usually laid very close together with only a sliver of grout separating them, giving near-perfect straight edges and exact dimensions. These tiles provide a very clean, symmetrical look, and allow for extremely fine grout lines of 3mm or less.

HUDSON



(cream) (grey)

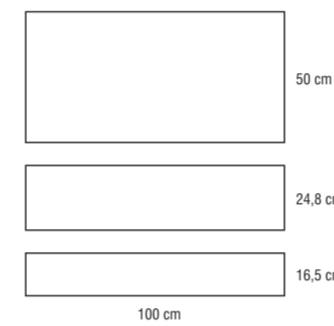

This beautiful selection of porcelain and ceramic **wood effect tiles** is an important addition to our original wood look tile collection. Stoneware tiles have the appearance of a wood material, but with all the advantages of tiles. These fascinating tiles in the design of wood, suitable indoors or outdoors, as well as private and commercial buildings. Stylish, unique and realistic recreations of wood.

Cement and **concrete** look tiles have grown in popularity for their minimalistic and modern look. Exposed concrete has moved on from being just an architectural industrial material to a source of inspiration for interior finishes. The urban material is now entering homes via the floors, walls, furniture and home accessories, bringing interesting textures and finishes in unexpected places. The beauty of concrete is it mixes so well with other materials, such as wood, marble, copper and brass, which can all tone down its brutalist tendencies.

TARRAGONA



(beige) (brown)

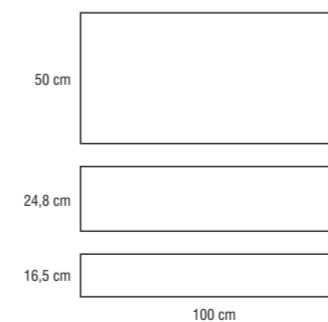

TAMPA



(grey)

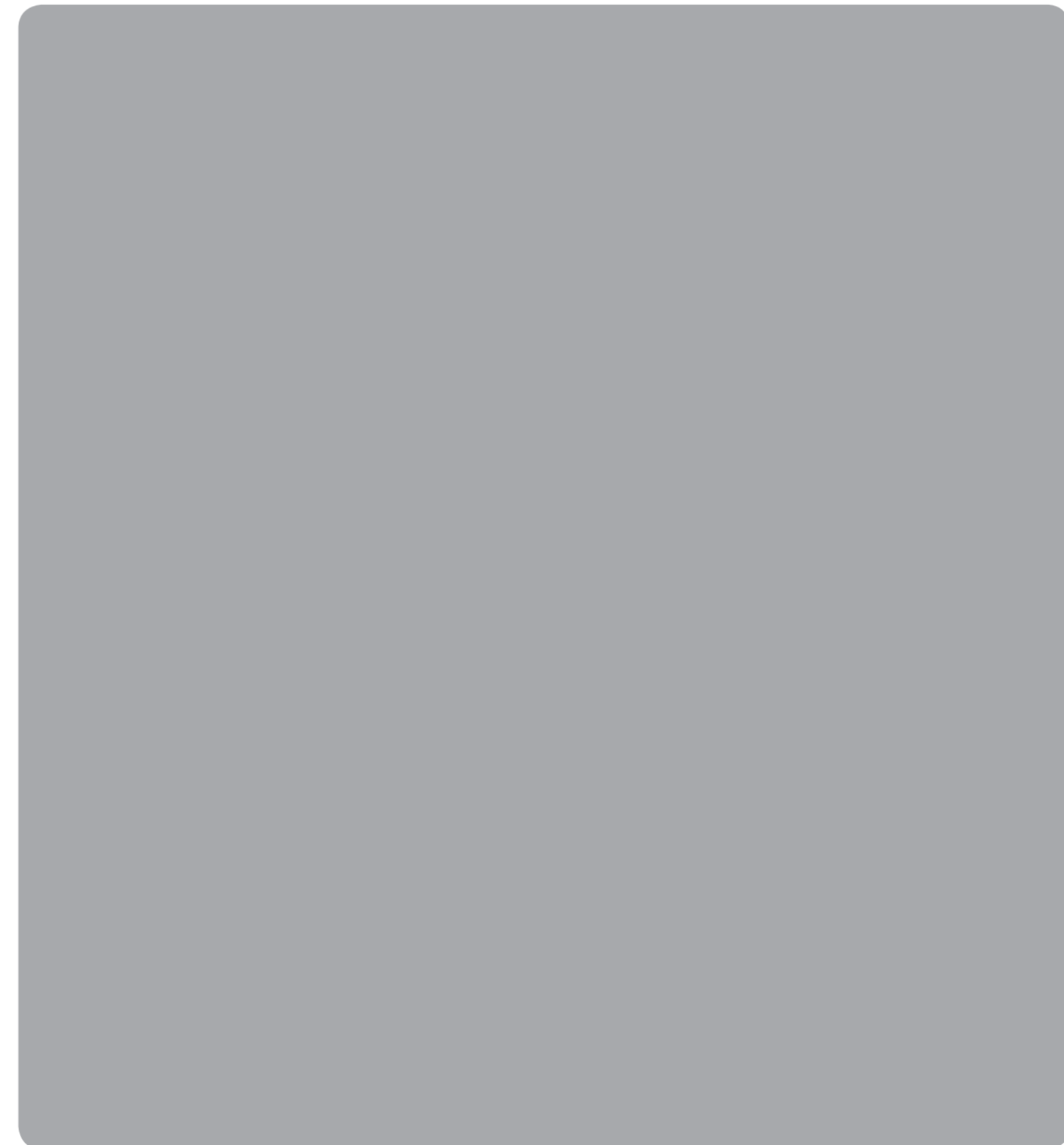
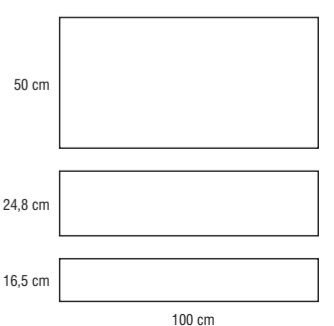

SAPPORO

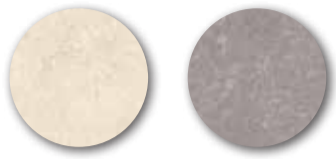

(beige)

(grey)

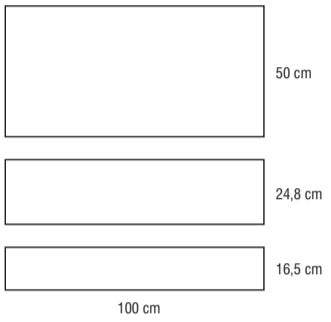

Stone-effect ceramic tiles are all about printed effects, metallics or mica flecks used to enhance the realism of stone looks, when it comes to genuine natural stone. The stone's natural colour - a deep and saturated taupe grey - also sits comfortably beside on-trend neutrals like greige, light grey and near white.

OASIS



(light grey)

(grey)

